

AUXILIARY HEATER AH454 (12V) or AH24454 (24V)

CONTENTS:

Heater • Mounting Brackets • Instruction Sheet • Installation Kit

INSTALLATION KIT INCLUDES:



(2) Y Splicers



(2) Rubber Grommets



(8) Hose Clamps



(4) Mounting Screws

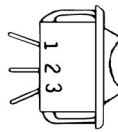

(1) Rocker Switch



(1) Switch Panel

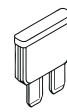

(1) 7.5A Fuse

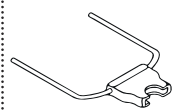

Fuse Holder

INSTALLATION DIAGRAM:

Materials required to install this heater are available in the kit shown above. In addition, you will need 5/8" heater hose and 14 GA wire which are NOT included in this kit.



FRONT VIEW

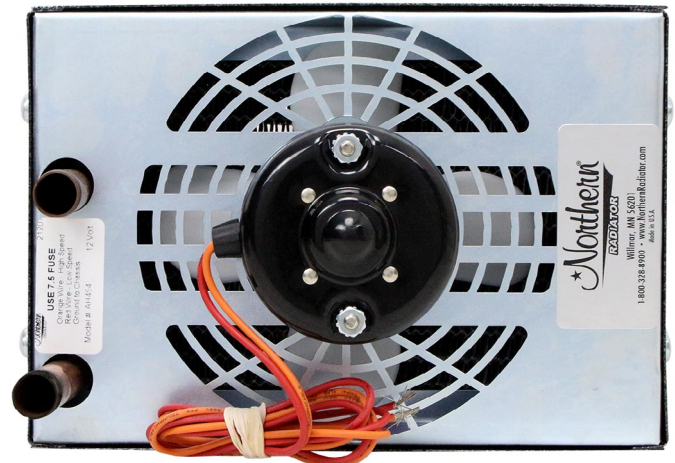

BACK VIEW

INSTALLATION INSTRUCTIONS:

1. This versatile heater may be mounted either horizontally or vertically. Typical locations include floor, wall or under dash. Mark the inlet and outlet tube locations and cut a hole through the vehicle's floor. Grommets are included but may not be required for below floor mounting. Mount the heater to the floor using the provided mounting brackets.
2. Route the heater hose to the engine compartment. We recommend the heater hose follow the inside of the frame rails for protection from road debris. Wire ties or clamps may be used to secure the hose to the frame. Please note that all hoses must clear all driveline or moving parts and must be securely fastened to the frame to avoid potential damage to the hose and cooling system. In the engine compartment, locate where the existing heater hoses pass through the fire wall. On the engine side of the fire wall, cut and insert the Y splicers in the existing heater hoses as close to the firewall as possible. Secure all the Y splicer connections with hose clamps, then install the new heater hose to the auxiliary heater. Avoid any sharp bends which may kink the hose and restrict proper flow. (See splicer diagram.)
3. Mount the switch panel in a convenient under dash location. Route power supply wire from fuse block to rocker switch including fuse holder with 7.5A fuse. Connect the red and orange wires from the heater to the switch extending them where necessary. Finally, ground the heater case to the chassis of the vehicle. We recommend all electrical connections are terminated or soldered and taped. (See the connection diagram below.)

WIRE CONNECTION DIAGRAM:

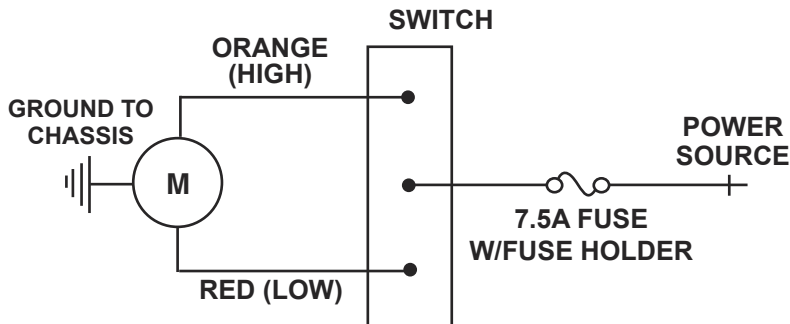

SWITCH CONFIGURATION:

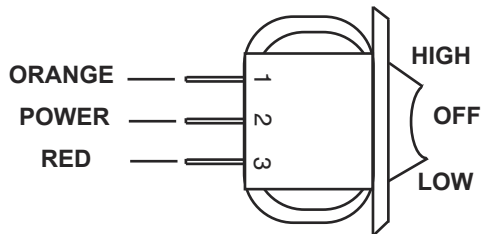

SPLICER DIAGRAM:

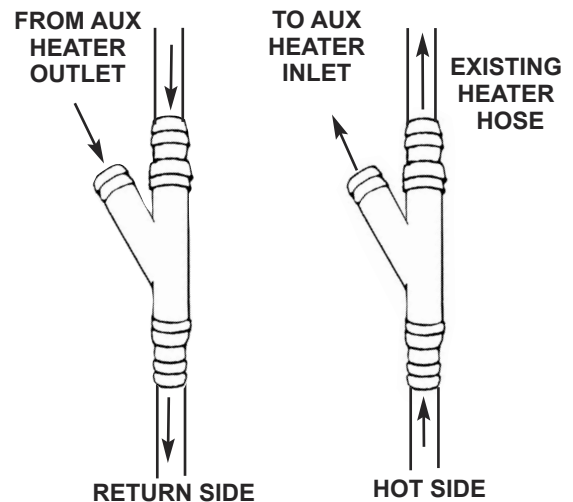

LIMITED WARRANTY

Northern Factory Sales warrants its Heaters to be free from all defects in manufacturing and workmanship for one year from the date of installation.

Any Heater claimed defective under this limited warranty should be forwarded to Northern Factory Sales, transportation charges prepaid, for inspection and warranty determination. (Contact customer service for return authorization prior to sending in.)

Northern Factory Sales will not be responsible for heaters damaged from misuse or neglect. Any expense associated with a warranty replacement, including but not limited to installation and transportation charges, are not covered under this warranty. This warranty provides for product replacement only. Any attempt at local repairs automatically voids this limited warranty.